

# Frequency Limitations Resulting from Mounted Resonance of an Accelerometer

Jack D. Peters, Connection Technology Center, Inc.

## Introduction:

Accelerometers are some of the best diagnostic sensors available today to measure machine vibrations and assist the trained analyst in the diagnosis of a potential problem developing with the machine. Faults such as imbalance, misalignment, bearing failure, gear failure, flow disturbances, or blade passing disturbances are just some of the many problems that can be detected with an accelerometer. All of these faults are sensed by the accelerometer through surface to surface contact with the machine.

Transmission of vibration from the machine to the accelerometer is only as good as the mounting of the accelerometer allows. Poor mounting methods can severely limit the ability of the accelerometer to measure those vibrations that it was designed for. Typical industrial accelerometers have usable frequency ranges as high as 15 kHz (15,000 cycles/second) or 900,000 CPM (cycles/minute). To achieve the full use of this upper frequency limit, the mounting must be very good to avoid a characteristic known as “Mounting Resonance”.

Mounting resonance is a direct result of lowering the accelerometers natural frequency and occurs as the result of reduced stiffness or increased mass. This is probably best described by viewing the formula where the stiffness is expressed in the numerator, and the mass is expressed in the denominator:

$$f_n = 1/2\pi\sqrt{k/m}$$

**f<sub>n</sub> = natural frequency**

**Where: k = stiffness**

**m = mass**

## Accelerometer Natural Frequency:

Initial design and construction of the accelerometer involves a much higher natural frequency than the usable range. This allows for tolerances to be placed on the usable range of  $\pm 5\%$ ,  $\pm 10\%$ , or  $\pm 3\text{dB}$ . Stiffness is accomplished by the rigid mounting of a piezoelectric element inside of the accelerometer. The size of the mechanical mass used to exert a force on the piezoelectric element, and provide the source of excitation, is based on the desired frequency output of the accelerometer. A lighter mass will produce a higher frequency output, and a heavier mass will produce a lower frequency output. Of course, a lighter mass will produce less force, and a heavier mass will produce more force, so the size of the mass is carefully balanced to provide both output frequency and amplitude characteristics.

Figure #1 is typical of a natural frequency response for an accelerometer. The regions of transmission, amplification due to resonance, and isolation have been marked for clarity.

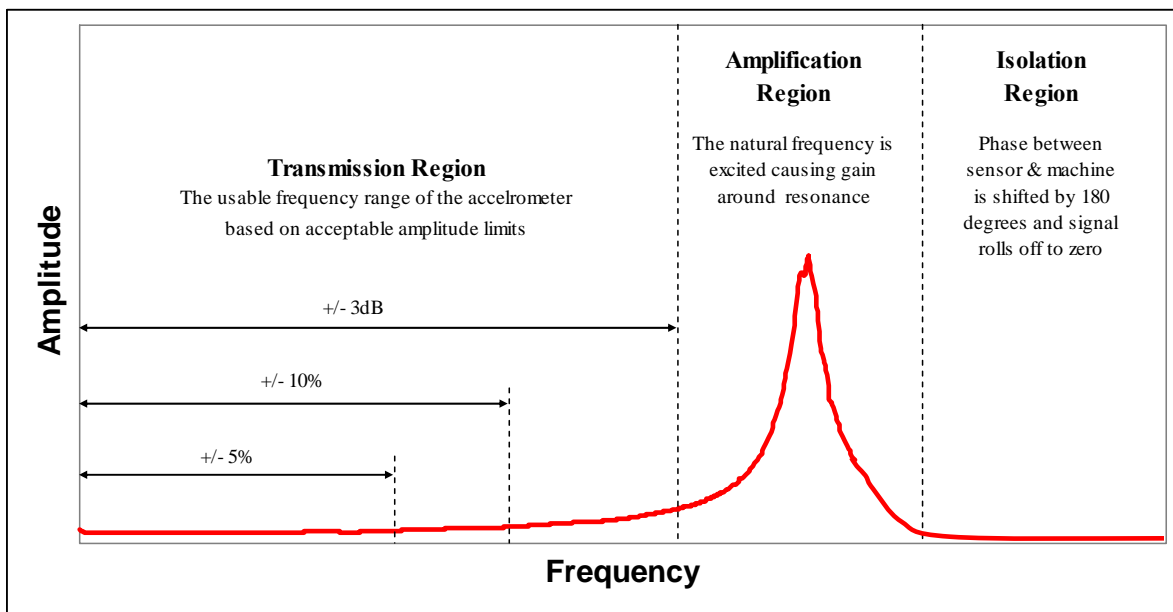

Figure #1 – Typical Natural Frequency Response of Accelerometer

**Functionality:**

The transmission region is the functional region for the accelerometer. The degree of accuracy within this region is described by the amplitude tolerances of +/- 5%, +/- 10%, and +/- 3dB. Although +/- 5% has the best amplitude tolerance, it will also have a limited transmission region. The largest transmission region will occur at the +/- 3dB amplitude tolerance, but put into linear units this is approximately - 30% or + 40% in amplitude tolerance. Initially the +/- 3dB tolerance would seem to be excessive, but it is used over and over in the industry with a great deal of success. These tolerances are produced during the manufacture of the accelerometer, and are essentially fixed for the life of the accelerometer provided it does not get damaged. Since most programs are based on trended history, and not absolute amplitude, the application of a +/- 3dB tolerance is acceptable.

The amplification region is the direct result of excitation of the natural frequency and occurrence of resonance. This region is capable of producing very large gains in the vibration signal. This can cause the vibration levels to appear much higher than they actually are. Typically, the data in the amplification region is not used. There are some techniques that do use the amplification region to achieve early warning of mechanical faults through high frequency detection, but they will not be discussed at this time, and are best left to various manufacturers of vibration instrumentation that are applying them in several different application programs.

The isolation region is an area of phase shift and signal loss. A phase shift of 180 degrees occurs after passing through resonance. Minimal vibration is measured in this region, and essentially data is lost when operating above the natural frequency.

## Mounted Resonance:

Under ideal circumstances, the accelerometer mounting should provide total use of the transmission region. Although this is an excellent goal for any analyst to have, it is totally dependant on the mounting method used. Remember, the natural frequency of an accelerometer is based on its stiffness and mass, and anything that modifies these characteristics during the mounting of the sensor will shift this natural frequency. Unfortunately, this shift in resonance always reduces the usable range of the accelerometer. The accelerometer is not broken, or any less worthy than it was designed, it is just altered during the mounting process.

There are several different mounting methods available, and Figure #2 is a manufacturer's chart indicating some of these methods, and the expected useable frequency ranges for the transmission of machine vibrations to the accelerometer.

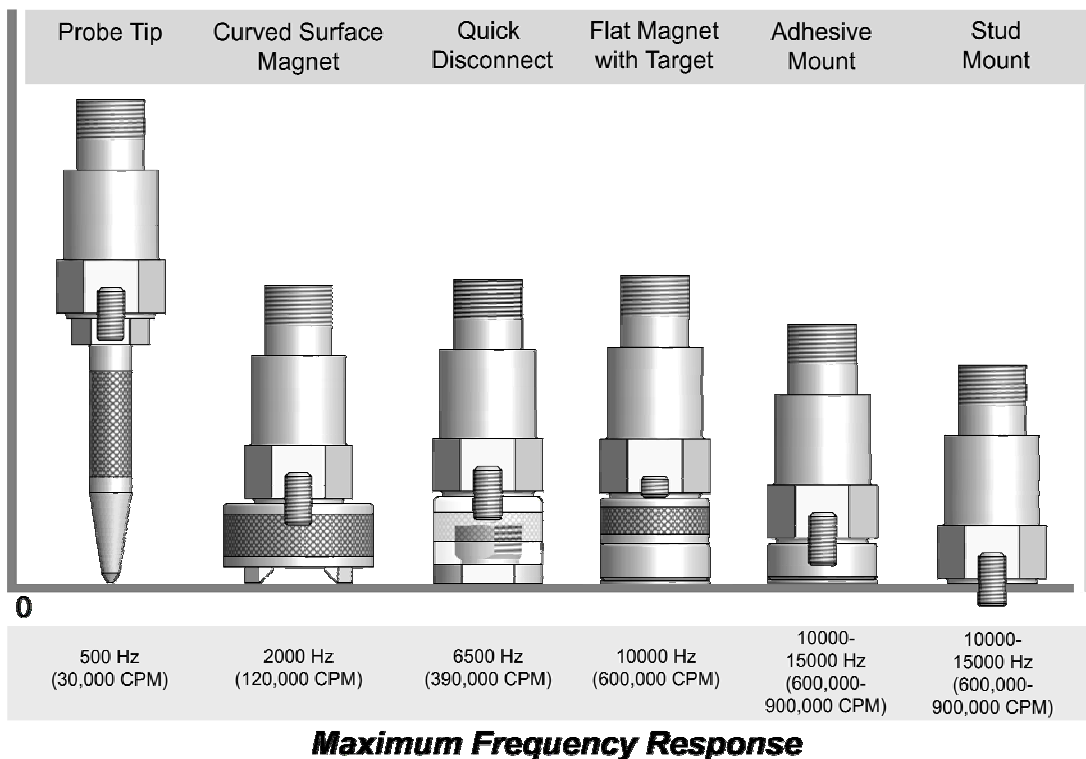

Figure #2 – Mounting Methods and Usable Frequency Range

Relative to Figure #2, there are a couple of methods that are used much more than the others, and this investigation will look at the resulting changes in mounted resonance for each of them.

The curved surface magnet, sometimes referred to as a two bar or two pole magnet, is probably the most popular method of mounting for portable vibration measurements. It fits well on curved surfaces like bearing housings, and quickly lets the vibration analyst move it from the vertical, horizontal, or axial locations of each bearing. Typically the curved surface magnet will offer usable transmission of vibration up to 2000 Hz.

Stud mounting requires a smooth machined surface with a drilled and tapped hole. This type of mounting is best suited to permanent vibration monitoring where an accelerometer will be installed and left on the machine for each and every location that vibration will be measured. This is often referred to as the reference mounting because it will typically provide a usable transmission of vibration up to the limits of the accelerometer.

### **Analysis of the Two Mounting Methods:**

In order to analyze these two methods of accelerometer mounting, there will need to be some vibration instrumentation and techniques employed to simulate a vibrating machine.

- A vibration shaker, with a calibrated standard reference accelerometer built into it, will be used to simulate the machine vibration. It will provide a controlled vibration disturbance across the entire frequency range of the test. The reference accelerometer will be considered as the input, and compared to the accelerometer under test (output). The shaker is limited to 10,000 Hz maximum frequency range.
- A function generator will be used to drive the shaker with random noise and simulate the multitude of vibration disturbances common to industrial machines. It would be very rare

to have a machine that generates only one vibration or frequency disturbance, and the application of random noise will have a better simulation of industrial machinery vibrations and frequency disturbances.

- An accelerometer to test employing the desired mounting method on the shaker.
- A dynamic signal analyzer will be used to capture the data, and display the results of the test in five different formats.
  - 1) The power spectrum (FFT) of the *reference accelerometer* indicating amplitude vs. frequency. (Input)
  - 2) The power spectrum (FFT) of the *test accelerometer* indicating amplitude vs. frequency. (Output)
  - 3) The frequency response generated by dividing the output of the test accelerometer by the input of the reference accelerometer. The ideal response in amplitude would be a value of one (unity gain), but it will also indicate the gain produced at resonance.
  - 4) The coherence indicating the percentage of output of the test accelerometer that is related to the input of the reference accelerometer. This is often referred to as Linear Causality.
  - 5) The phase between the two accelerometers. The reference accelerometer and test accelerometer should be in phase with each other in the transmission region and prior to resonance. After resonance, these two sensors will be out of phase with each other.

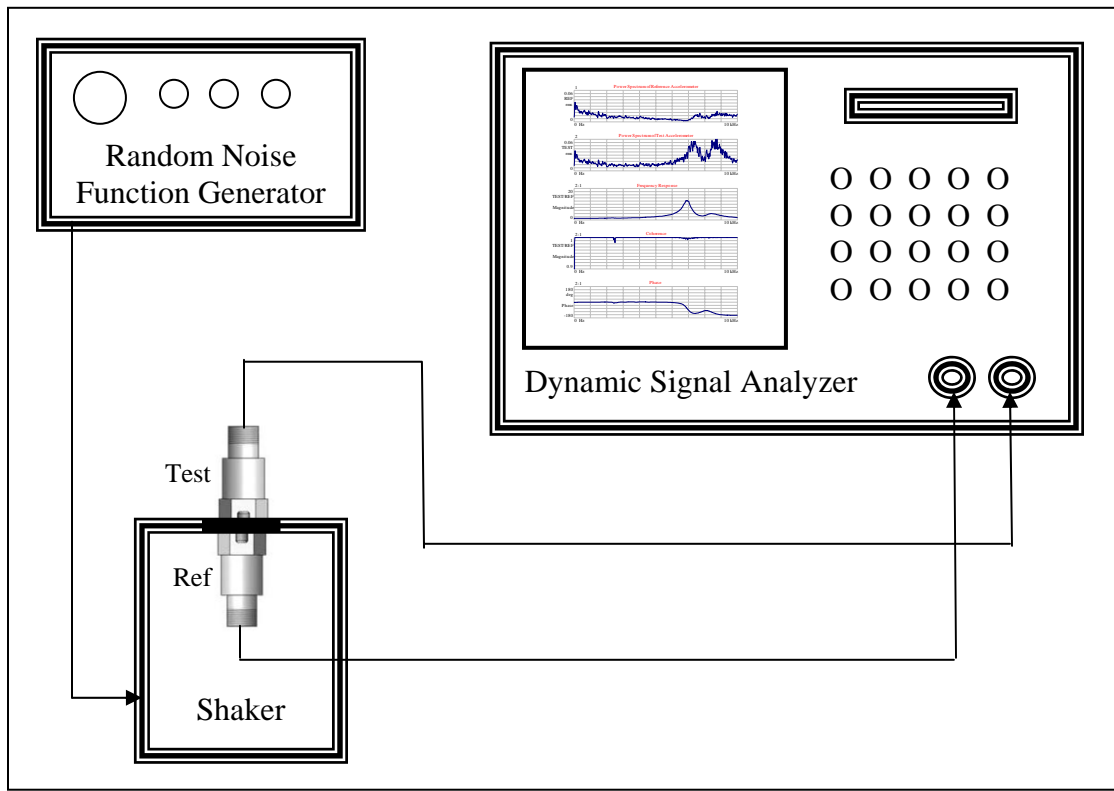
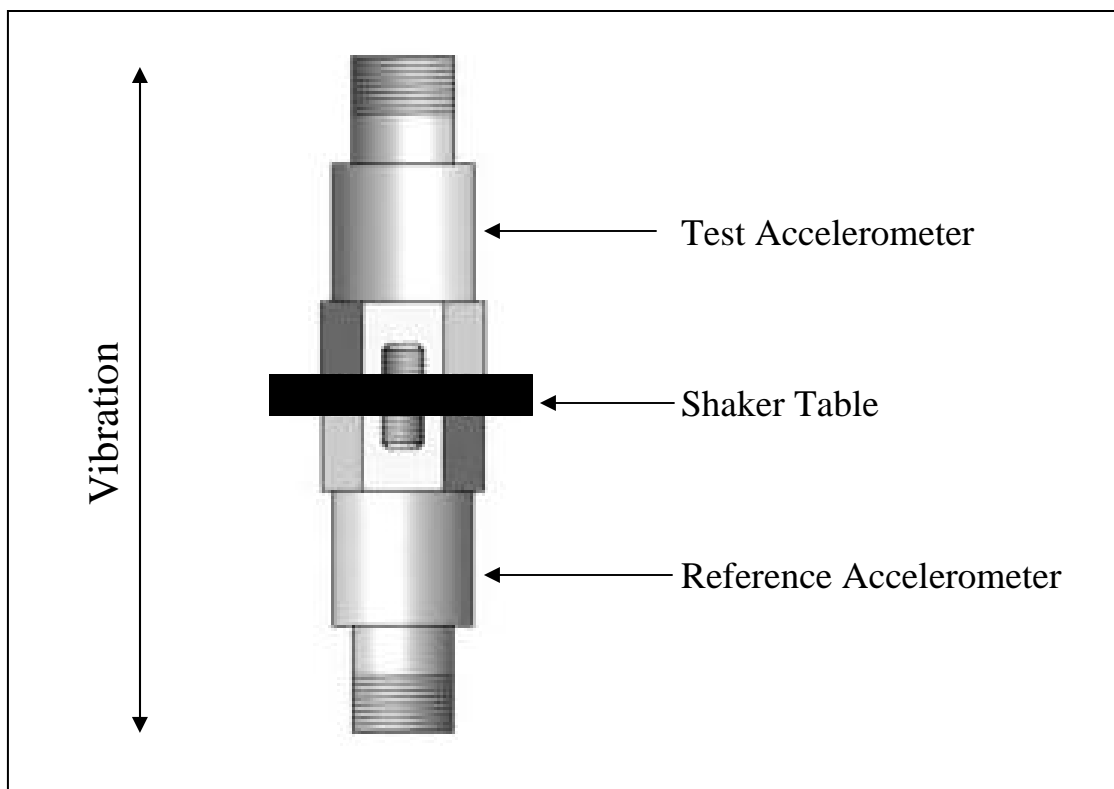

*Figure #3 – Test Set-up*

As shown in Figure #3, the random noise function generator supplies the electrical signal to drive the shaker. The reference accelerometer is built into the shaker and the test accelerometer is mounted on top of the shaker. The signal for the reference accelerometer is applied to channel one of the dynamic signal analyzer, and the signal for the test accelerometer is applied to channel two of the dynamic signal analyzer. Channel one and the reference accelerometer will be considered the input for testing purposes. Channel two and the test accelerometer will be considered the output for testing purposes. The mounting method under test will be applied between these two accelerometers and the output compared to the input.

## Stud Mounting:

Stud mounting is accomplished with a drilled and tapped hole using a threaded fastener between the accelerometer and the machine. During testing and calibration, this is often referred to as “back to back” mounting. The accelerometers are essentially bolted together on the shaker, with the shaker table in the middle between them. Figure #4 is an illustration of the back to back mounting technique.



*Figure #4 – Back to Back Accelerometer Mounting on Shaker Table*

The application of random noise from 0 – 10,000 Hz will cause the shaker to oscillate (vibrate) both sensors simultaneously. In this manner the two sensors can be compared to each other with the dynamic signal analyzer. Figure #5 represents the results obtained with the back to back mounting method.



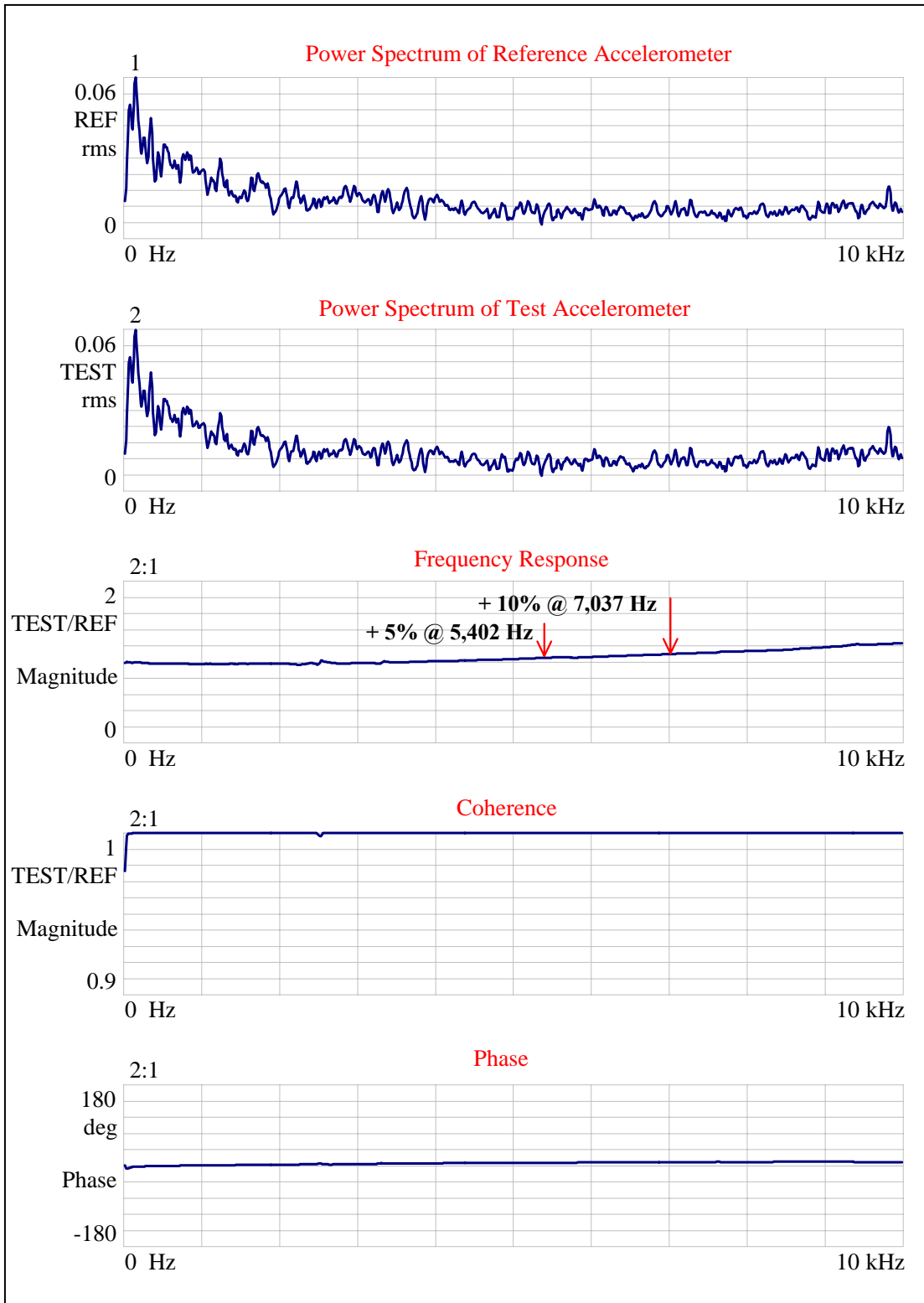

Figure #5 – Back to Back Mounting Results

Analysis of the data measured in Figure #5 indicates that the power spectrums for the reference accelerometer and test accelerometer are almost identical. Frequencies and amplitudes are well matched in both power spectrums.

The frequency response approximates a gain of one, with the +5% limit at 5,402 Hz, and the +10% limit at 7,037 Hz. The +3dB limit was never exceeded. This would provide a transmission range, within the 3 dB limit, up to at least 10, 000 Hz and probably higher if it had been within the scope of the measurement.

The coherence is very good and provides an indication that 100% of the vibration measured by the test accelerometer was caused by the shaker and reference accelerometer.

The two sensors are in phase with each other, and indicate that they are operating below resonance.

### **Magnet Mounting:**

The curved surface magnet has the accelerometer attached to it by a threaded stud. However, when the assembly is placed on the machine to measure vibration, the attachment to the machine is accomplished by two magnetic bars. Transmission through the magnet is accomplished by two lines of contact and the pull force of the magnet. This provides limited surface area and stiffness for the assembly. The magnet itself adds significant mass to the accelerometer. The loss of stiffness and the increase in mass will reduce the resonant frequency of the sensor and magnet combination. This mounted resonance will be much lower than the capabilities of the accelerometer without the magnet. Figure #6 illustrates the magnet mount and reference accelerometer for testing purposes.

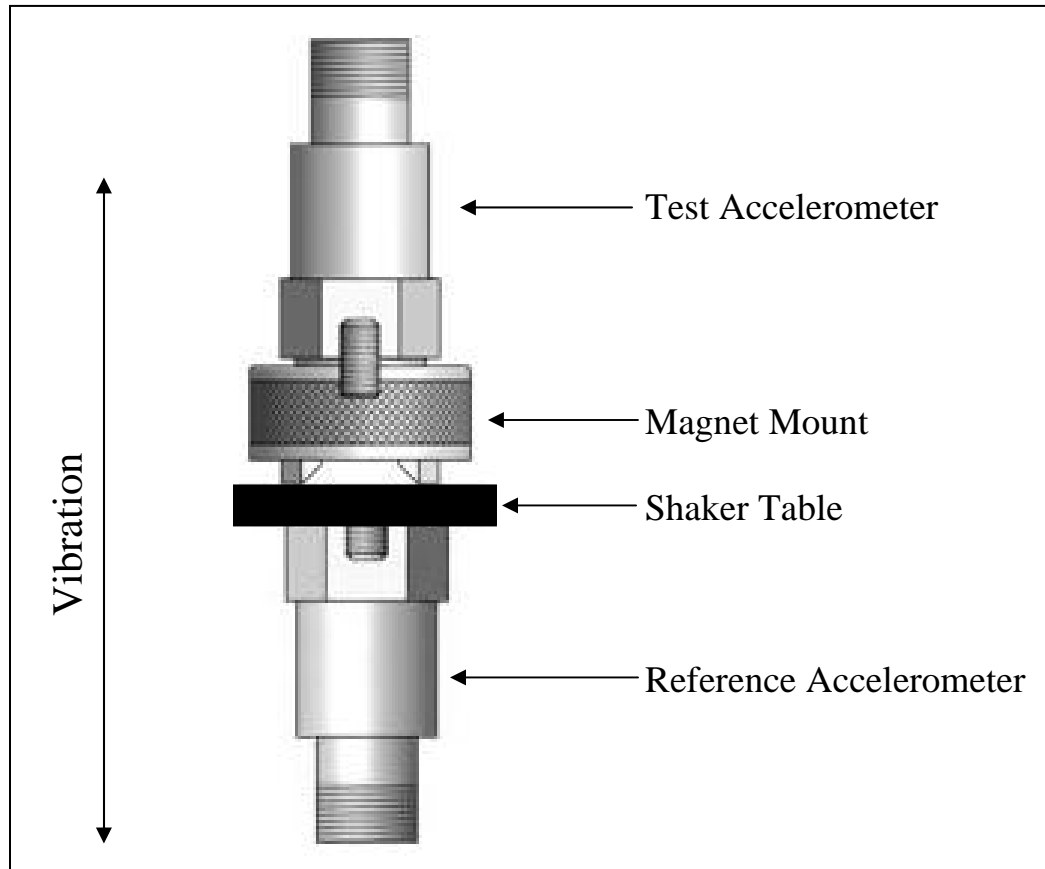

*Figure #6 – Magnet Mounting Accelerometer on Shaker Table*

The application of random noise was again applied to the shaker over the frequency range of 0 – 10,000 Hz. The same measurements were made on the magnet mounting that had been previously made on the stud mounting. Figure #7 represents the results obtained with the magnet mounting method.

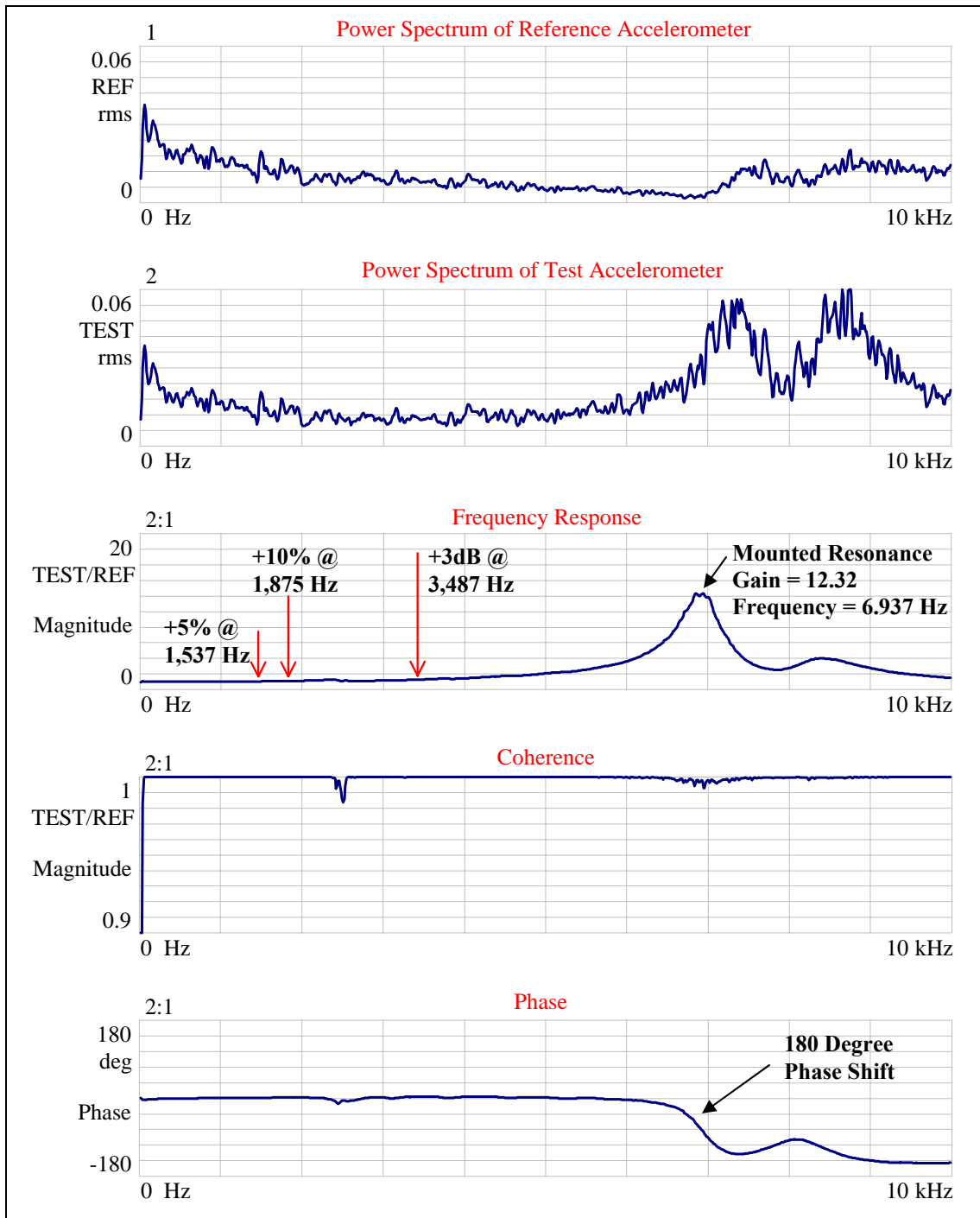

Figure #7 – Magnet Mounting Results

Analysis of the data measured in Figure #7 indicates that the power spectrums for the reference accelerometer and test accelerometer are very different. Amplitudes are significantly higher in the test accelerometer above 5000 Hz.

The frequency response is limited to a transmission range below the resonant frequency of 6,937 Hz. The +5% limit is 1,537 Hz, the +10% limit is 1,875 Hz, and the +3dB limit is 3,487 Hz. The resonant frequency at 6,937 Hz has a gain of 12.32. If an amplitude of 1 inch/second were applied to the shaker at 6,937 Hz, the mounting resonance would cause a vibration measurement of approximately 12.32 inches/second on the output of the test accelerometer.

The coherence is very good and provides an indication that 98% of the vibration measured by the test accelerometer was caused by the shaker and reference accelerometer. Keep in mind that the amplitude of the signal is displayed in the frequency response, and that the coherence is a measure of causality.

The two sensors are in phase with each other below 6,937 Hz, and out of phase with each other above 6,937 Hz. Above resonance, if the test accelerometer is measuring a positive going signal, than the reference accelerometer is measuring a negative going signal. Essentially, the two signals will cancel each other out above resonance because they are out of phase by 180 degrees.

### **Summary:**

It is difficult to match the typical performance in Figure #1 with the actual results in Figure #7. Small inconsistencies in the mounting methods, system performance, and broad frequency response at resonance, in the actual measurement, prevent ideal correlation to the typical performance characteristics. These small inconsistencies are faced on a daily basis by the

vibration analyst. It does not take away from the testing though, and in actuality the typical performance is well represented by the outcome of the testing.

Back to back mounting of the two sensors provided a very wide transmission range, and even at 10,000 Hz, the +3dB limit was not exceeded. This clearly indicates that stud mounting the accelerometer to the machine would give the best possible frequency response, and is an ideal method for permanently mounted accelerometers. A flat prepared machine surface with a drilled and tapped hole, to mount the accelerometer stud, should provide the full frequency range of the accelerometer's design specification.

Recommendations for curved surface magnet mounting are typically limited to a maximum of 2,000 Hz. Testing for this investigation actually yielded a +3 dB limit of 3,487 Hz. This improved result is probably caused by the flat surface of the shaker table. The two bars in the magnet had significantly more surface area and better stiffness on a flat surface than the lines of contact that would be experienced on an actual curved bearing housing. The mounting resonance was identified, and the reduced transmission range was apparent. Although the curved surface magnet is very useful and convenient for portable vibration measurements, the user needs to be aware that the frequency response is limited, and measurements at mounted resonance will be higher than expected, and measurements above resonance will be lower than expected and eventually approach zero.

There are other portable mounting methods that will provide increased transmission ranges, and a quick disconnect or flat surface magnet are excellent examples. However, each of these designs requires surface preparation and the mounting of a permanent target to achieve as much surface to surface contact and stiffness as possible. If portable data collection requires the measurement of vibration above 2,000 Hz, then one of these alternatives should be considered.

## **Bibliography:**

- *Effective Machinery Measurements using Dynamic Signal Analyzers*, Application Note 243-1, Agilent Technologies
- *Piezoelectric Accelerometers and Vibration Preamplifiers Theory and Application Handbook*, Bruel & Kjaer
- *Shock and Vibration Handbook*, Cyril M. Harris

## **Authors Biography:**

**Jack D. Peters** is a Regional Manager for Connection Technology Center, Inc. (CTC) His regional responsibilities include Asia/Pacific, Canada, and South Africa. He has more than 25 years of experience in measuring, monitoring, and analyzing vibration problems on process manufacturing machines for photographic films and papers. He currently provides senior engineering leadership, training for distribution partners, engineering support, and applications engineering for customers at CTC. He holds an AOS degree from Alfred Agricultural & Technical College and an AAS degree from Monroe Community College. Mr. Peters is an Instructor for the National Vibration Institute, Chairman of the Central New York Chapter of the Vibration Institute, and certified as a Vibration Analyst Category IV in accordance with ISO 18436-2.

Jack D. Peters  
Connection Technology Center, Inc.  
590 Fishers Station Drive  
Victor, New York 14564

Tel: 585-924-5900 x834  
Email: [jpeters@ctconline.com](mailto:jpeters@ctconline.com)